

BUT DE BASKET MOBILE HAUTEUR FIXE JUSQU'À 3,05m
GOAL OF BASKET-BALL FIXED HEIGHT UP TO 3,05m

DOC N°:

NDM_BB130210-A

REF :	PAIRE / PER	UNITÉ / UNIT
BB130210-A	-	141 KG



AVERTISSEMENT :

- A chaque mise en place des équipements, un contrôle visuel et manuel de stabilité et de solidité sont obligatoires.
- Cet équipement doit impérativement être fixé pendant son utilisation ou être rendu inutilisable lors de son stockage.
- Les équipements doivent être entretenus par leur exploitant/gestionnaire de façon à ce qu'ils répondent en permanence aux exigences de sécurité.
- Le exploitant/gestionnaire doit établir un plan des vérifications périodiques et d'entretien des équipements.
- Réaliser un registre comportant, pour chaque site, la date et le résultat des contrôles et essais réalisés.
- Tout équipement non conforme aux exigences de sécurité doit être rendu inaccessible aux usagers par le propriétaire ou l'exploitant.
- Ne pas utiliser ce matériel pour un usage autre que celui pour lequel il est prévu à l'origine.
- Ne pas se suspendre, grimper, se balancer sur cet équipement.
- Le propriétaire doit se reporter à la garantie produit qui lui a été remise.



WARNING :















- Each time the equipment is installed, it is essential to check the stability and strength of the goal visually and manually.
- The equipment must always be secured during use and be made unusable during storage.
- The equipment must be serviced by the owner to ensure it complies with safety requirements at all times.
- The owner must set up a periodic inspection and servicing schedule for the equipment.
- A log must be kept for each site, recording the date and result of the inspections and checks performed.
- The owner or operator must ensure that users are unable to access any equipment which does not comply with the safety requirements.
- Do not use this equipment for any purpose other than that for which it was originally designed.
- Do not hang from, climb up or swing on this equipment.
- The owner should refer to the product warranty that was given to him.

Nomenclature des composants / List of components

Description visuelle Visual description	Qté Qty	Repère Landmark
	1	A
	1	B
	2	C
	1	E
	1	F
 OU / OR	1	G
	1	-

Référence Reference
CHARBB004
MATBBO31
HAUBB002
20I0324
BB03I133
BB130107DL/RE (cf. NDM_BB130107)

Détail du sachet / Retail bag

Description visuelle Visual description	Qté Qty	Repère Landmark	
	100x100	2	H
	M10 x 30	6	I
	M8 x 20	2	J
	Ø12 (Ø30x1,5)	4	K
	Ø10 (Ø30x2,5)	6	L
	Ø8 (Ø25x1,5)	2	M
	M12	4	N
	M12	4	O
	M12 x 180	2	P
	Ø12 (Ø37x3)	2	Q
	M12x50	2	R
		1	S
	M12x20	2	T
		1	U

Référence Reference
4070215
4053340
4053200
4046130
4047200
4046112
4021140
4062014
4053457
4046131
4058611
4058612
4058610
4090211

Implantation du but / Positioning of equipment

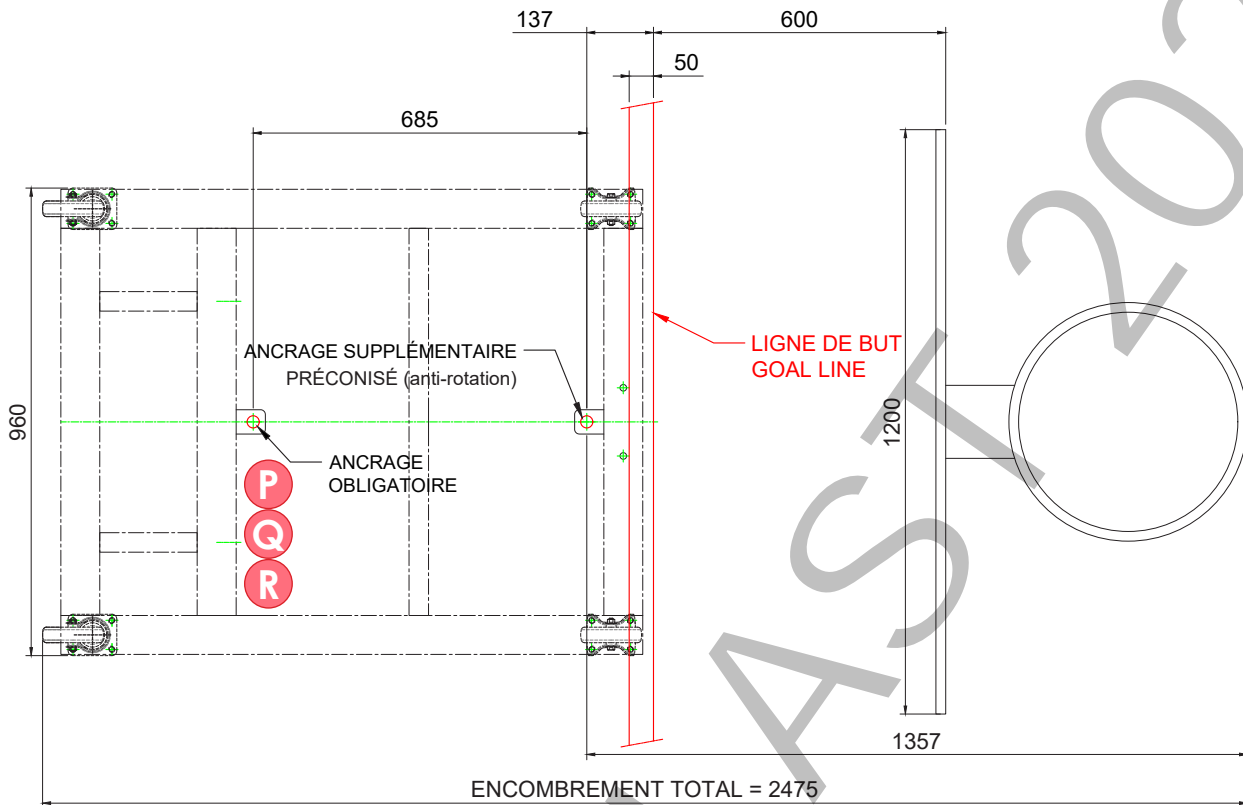

Mise en œuvre Implemented

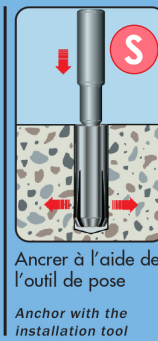
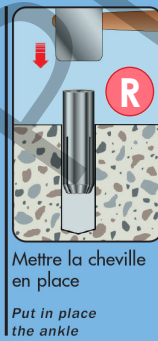
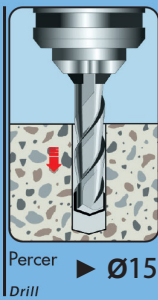

Montage / Assembly

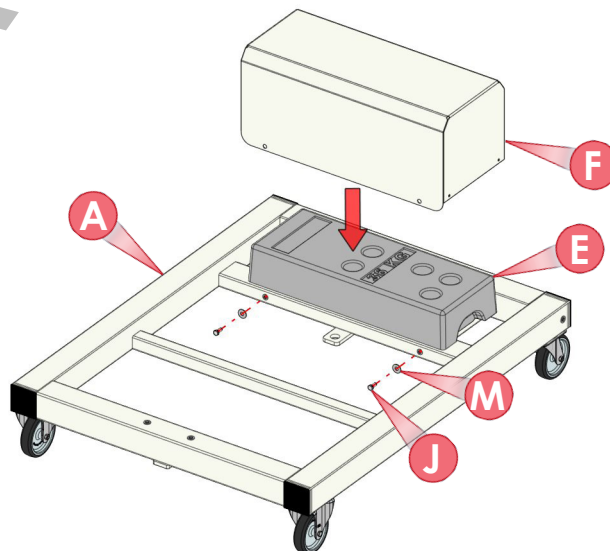

Montage / Assembly

