

DOC N°:

NDM_TN080223-A

CONFORMITE / CONFORM TO :

NF EN 1510 - F.F.T. - I.T.F.

ACIER / STEEL REF : TN080201-A, TN080202, TN080211-A, TN080212

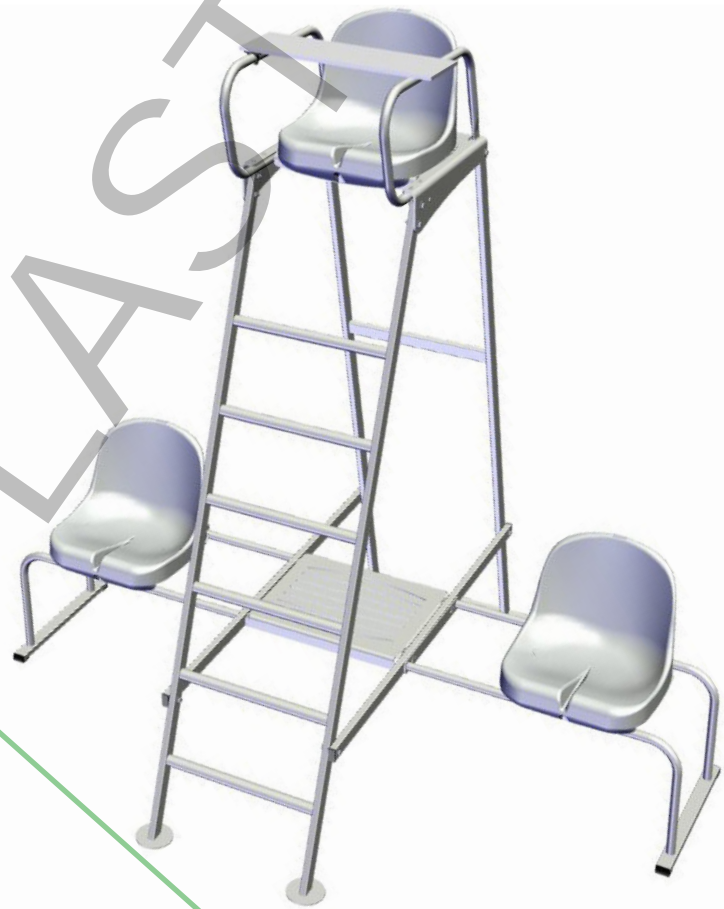





ALUMINIUM REF : TN080223-A, TN080224-A, TN080225, TN080226-A,
TN080227, TN080229, TN080231-A, TN080239

Colisage / Packing

➔ TN 0802XX-A (chaise tout type/ every chairs)













Nomenclature des colis / List of packages

Description visuelle Visual description	Qté Qty	Poids Alu Weight (Kg)	Poids Acier Weight (Kg)	Dimension colis Package size (mm)	Repère Landmark
 ALU ACIER	1	4,5	10,5	2200 x 660 x 150	A
	1	2,5	7,7		B
 1300	2	0,5	4,2		C
	1	13	23	600 x 500 x 550	

Détail des colis accessoires / Retail package accessories :

Description visuelle Visual description	Qté Qty	Repère Landmark
	1	D
	1	E
	1	F
 Ø25	2	G
 550*173*10	1	H
	1	



Détail du sachet / Retail bag : SATN0005

Description visuelle Visual description	Qté Qty	Repère Landmark	
	M6x20	1	I
	M8x20	6	J
	M8x40	8	K
	M8x50	8	L
	M10x25	2	M
 INOX	Ø6	2	N
	Ø8	32	O
	Ø10	4	P
	M6	1	Q
	M8	16	R
	M10	2	S
	4,8x25	4	T
	Ø39	2	U







Nb colis / Pack : 2

➔ TN 080202 & TN080212 & TN080225 & TN080227 & TN080229 & TN080239

Nomenclature des colis / List of packages

Description visuelle Visual description	Qté Qty	Poids Alu Weight (Kg)	Poids Acier Weight (Kg)	Dimension colis Package size (mm)	Repère Landmark
	2	6	6	820 x 520 x 600	A
	2	8	18		B
	1	0,25	0,25	100 x 150	

Détail du sachet / Retail bag : SATN0006

Description visuelle Visual description	Qté Qty	Repère Landmark
 M10x50	4	C
 Inox Ø6	2	D
 Ø10	8	E
 M10	4	F
 4,8x25	2	G
 Ø39	4	H

Nb colis / Pack : 1

Montage / Assembly

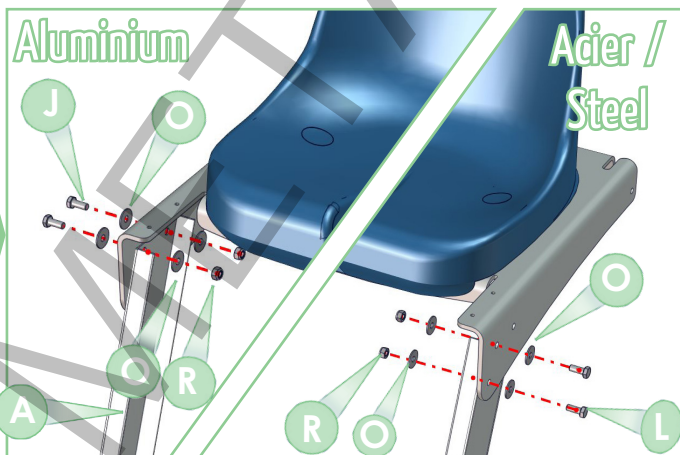
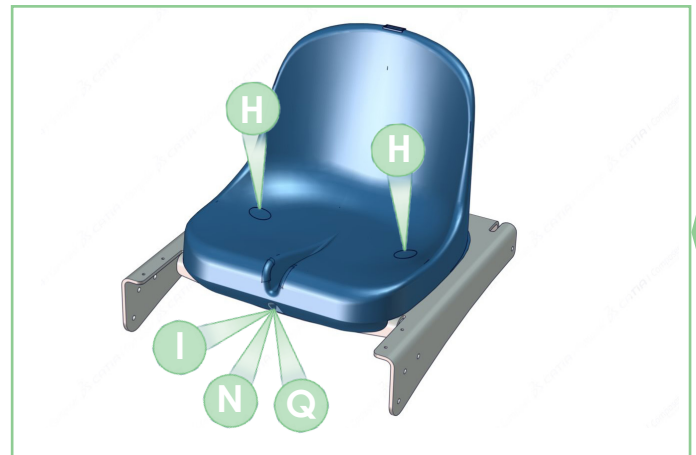
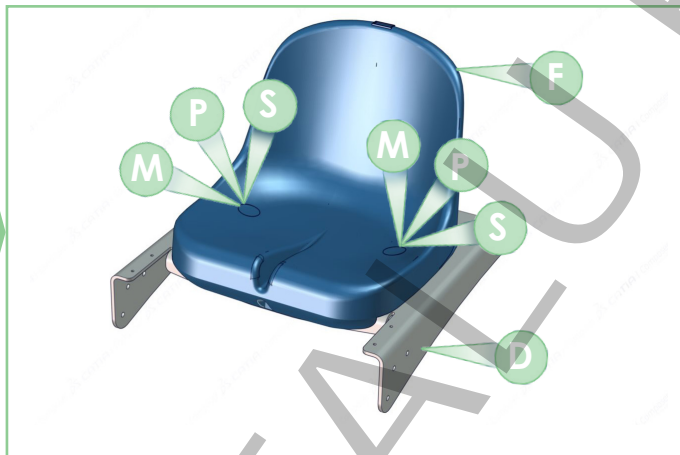

5

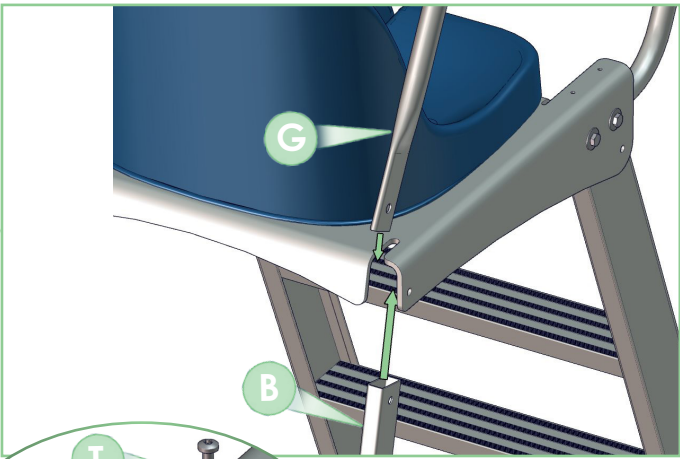

6

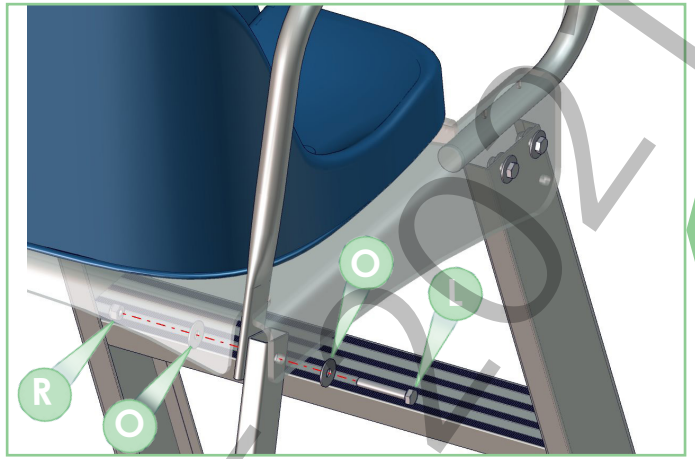

7

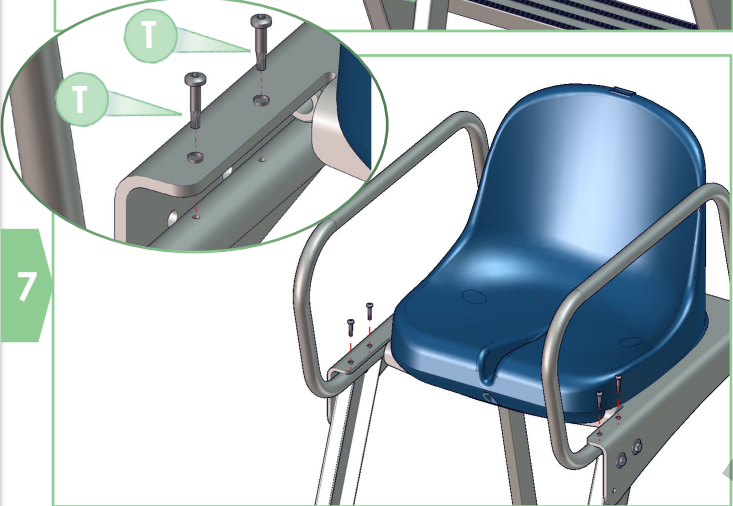

8

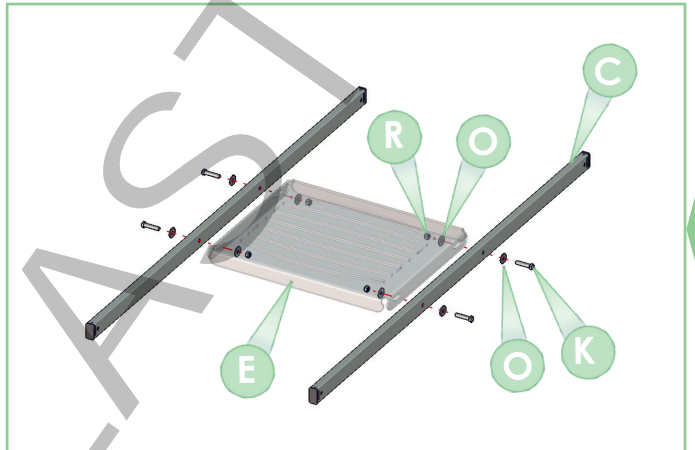

9

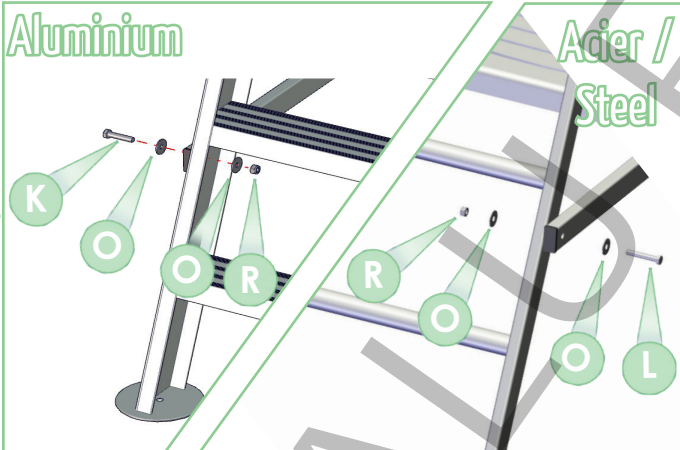

10

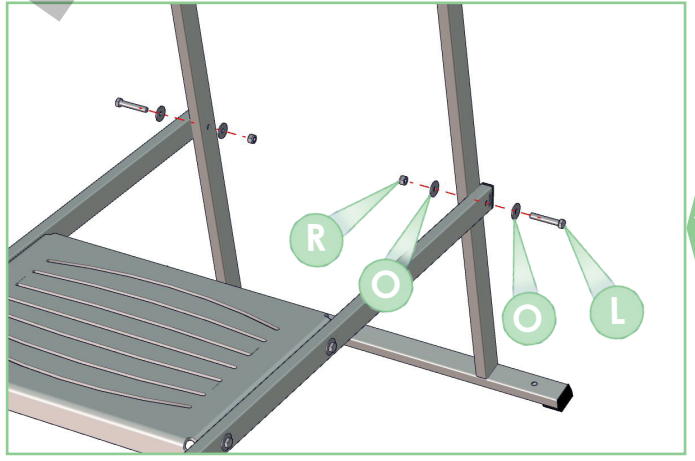

11



12

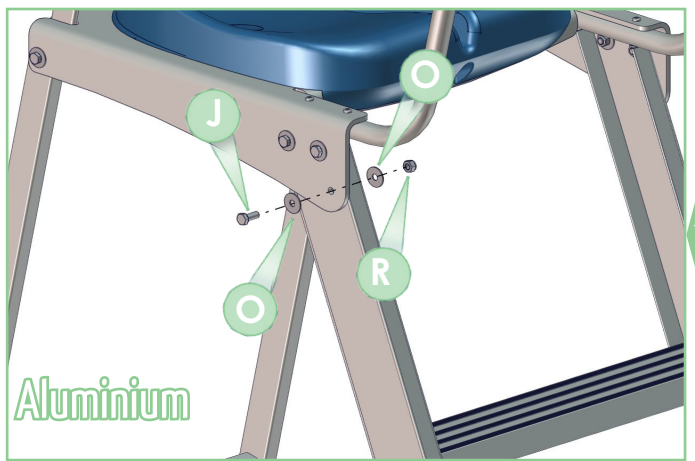

Montage avec chaises latérales / Assembly with side chairs

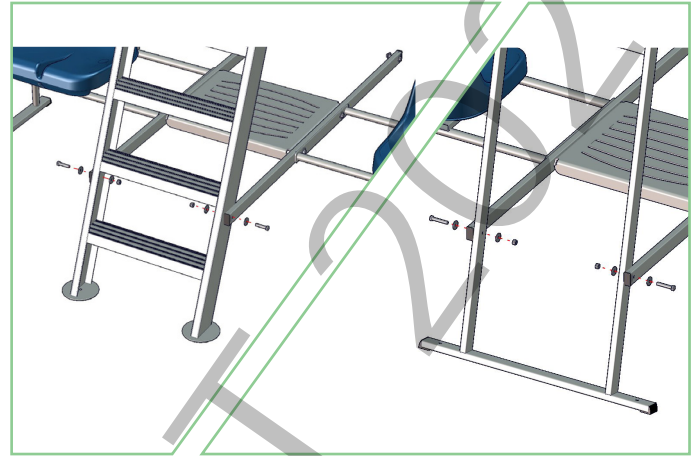
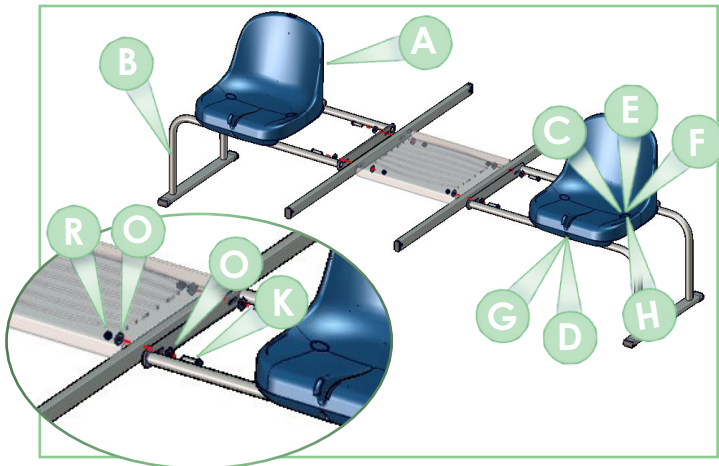

11

13

17



Acier / steel



Aluminium

REF :	CHAISE/CHAIR	CHAISES LAT/ SIDE CHAIRS	REF :	CHAISE/CHAIR	CHAISES LAT/ SIDE CHAIRS
TN080201/211 - A	46 KG		TN080223/224/226/231 - A	21 KG	
TN080202/212		25 KG	TN080225/227/229/239		15 KG



AVERTISSEMENT :

- A chaque mise en place des équipements, un contrôle visuel et manuel de stabilité et de solidité sont obligatoires.
- Cet équipement doit impérativement être fixé pendant son utilisation ou être rendu inutilisable lors de son stockage.
- Les équipements doivent être entretenus par leur propriétaire de façon à ce qu'ils répondent en permanence aux exigences de sécurité.
- Le propriétaire doit établir un plan des vérifications périodiques et d'entretien des équipements.
- Réaliser un registre comportant, pour chaque site, la date et le résultat des contrôles et essais réalisés.
- Tout équipement non conforme aux exigences de sécurité doit être rendu inaccessible aux usagers par le propriétaire ou l'exploitant.
- Ne pas utiliser ce matériel pour un usage autre que celui pour lequel il est prévu à l'origine.
- Ne pas se suspendre, grimper, se balancer sur cet équipement.
- Le propriétaire doit se reporter à la garantie produit qui lui a été remise.



WARNING :

- Each time the equipment is installed, it is essential to check the stability and strength of the goal visually and manually.
- The equipment must always be secured during use and be made unusable during storage.
- The equipment must be serviced by the owner to ensure it complies with safety requirements at all times.
- The owner must set up a periodic inspection and servicing schedule for the equipment.
- A log must be kept for each site, recording the date and result of the inspections and checks performed.
- The owner or operator must ensure that users are unable to access any equipment which does not comply with the safety requirements.
- Do not use this equipment for any purpose other than that for which it was originally designed.
- Do not hang from, climb up or swing on this equipment.
- The owner should refer to the product warranty that was given to him.